

INSTRUCTIONS FOR USE
SIMPONI® (SIM-po-nee)
(golimumab)
injection, for subcutaneous use

This Instructions for Use contains information on how to inject SIMPONI using the SmartJect Autoinjector.

Please read this Instructions for Use before using SIMPONI SmartJect and each time you get a refill. There may be new information. This leaflet does not take the place of talking with your doctor about your medical condition or your treatment.

Important information

If your doctor decides that you or a caregiver may be able to give your SIMPONI injections at home, you should receive training on the right way to prepare and inject SIMPONI using SmartJect.

Do not try to inject SIMPONI yourself until you have been shown the right way to give the injections by your doctor or nurse.

Do not pinch the skin while injecting. Pinching the skin can cause failure of the device and injury, including needlestick injury.

Do not inject into the arm to avoid failure of the device or injury.



Store SIMPONI in the refrigerator at **36°F to 46°F** (2°C to 8°C).

Do not freeze SmartJect.

Do not shake SmartJect.

If needed, store SIMPONI at room temperature, up to 77°F (25°C) for one period of time up to 30 days. Do not return it to the refrigerator. Throw away (dispose of) if not used within 30 days at room temperature.

Keep SIMPONI in the original carton to protect from light before use.

Keep SIMPONI and all medicines out of the reach of children.

Your SmartJect at-a-glance

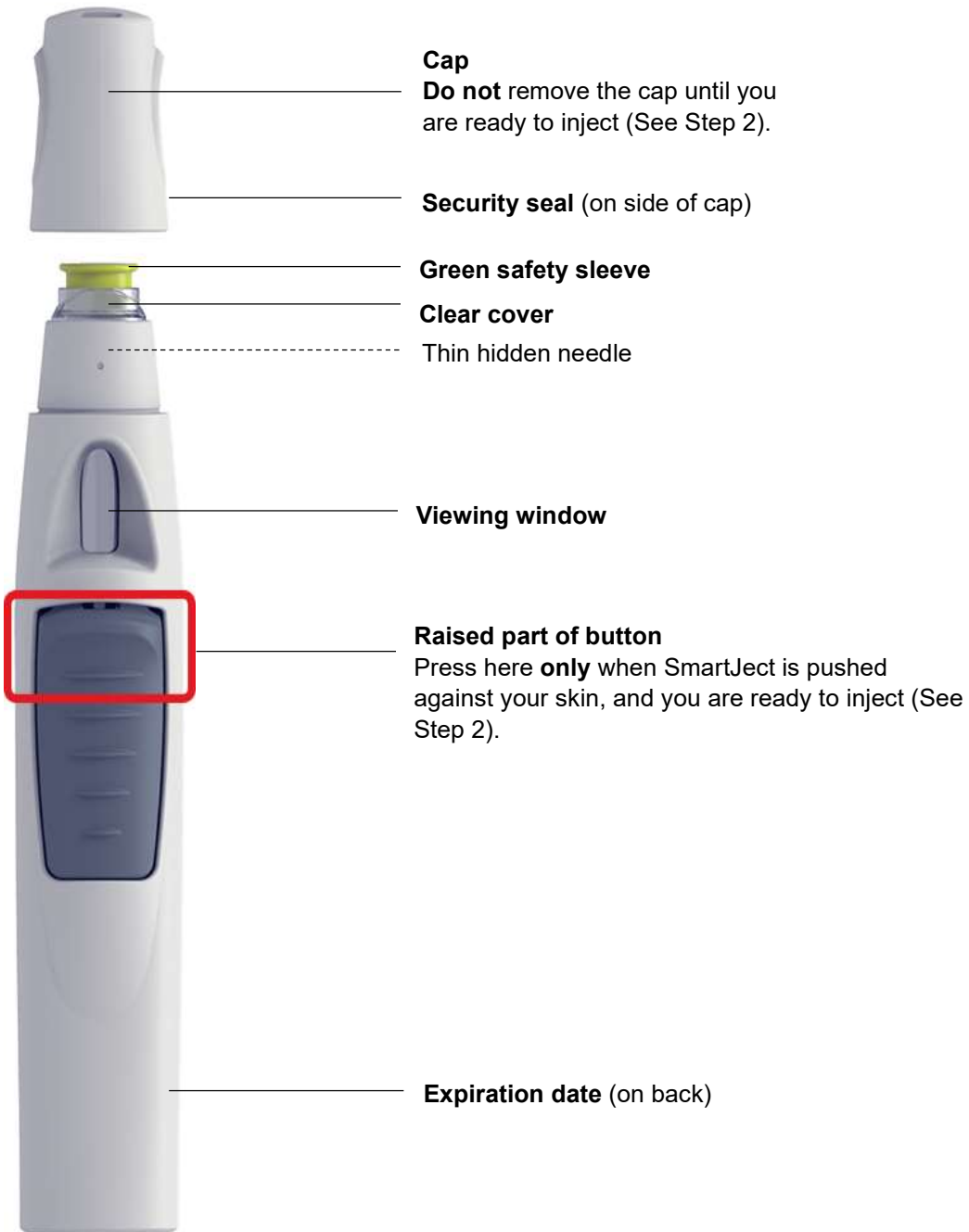

1. Preparing to inject SIMPONI using SmartJect

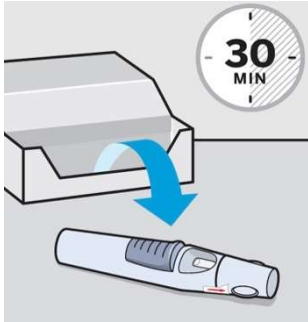

Take out SmartJect

Take SmartJect out of the refrigerator and remove it from the carton.

Place on a flat surface out of reach of children.

SmartJect should sit at room temperature for **at least 30 minutes** to ensure proper injection.

Do not warm any other way.

Do not remove the cap yet.

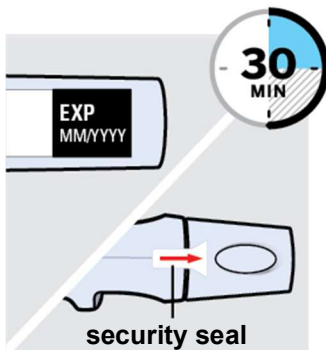

Inspect SmartJect

Check the expiration date ('EXP') on the back of SmartJect.

Do not use SIMPONI SmartJect if the expiration date has passed. Call your doctor or pharmacist for a refill.

Check the security seal on the cap.

Do not inject if the seal is broken.

Gather supplies

While SmartJect sits at room temperature for 30 minutes, gather your supplies:

- **1 Alcohol swab**
- **1 Cotton ball or gauze pad**

- **1 Sharps** container (See Step 3)

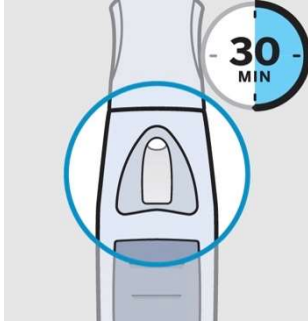

Check liquid in the SmartJect

After 30 minutes, check the liquid in the viewing window. It should be clear to slightly yellow and may contain tiny white or clear particles.

It is also normal to see a small air bubble.

Do not inject if the liquid is cloudy or discolored, or has large particles.

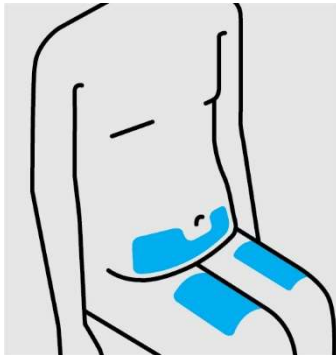

⚠ Do not inject into the arm to avoid failure of the device or injury.

Choose injection site

Select from the following areas for your injection:

- Front of thighs
- Lower abdomen (**do not** use the 2-inch area around your navel (belly-button))
- **Do not** inject into the arms

Choose a different site within your preferred area for each injection.

Do not inject into skin that is tender, bruised, red, scaly or hard. Avoid areas with scars or stretch marks.

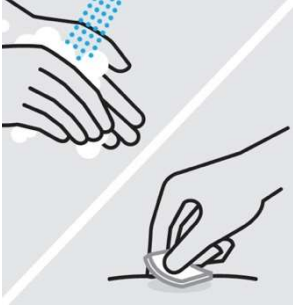

Wash hands and clean injection site

Wash your hands well with soap and warm water.

Wipe your chosen injection site with an alcohol swab and allow it to dry.

Do not touch, fan or blow on the injection site after you have cleaned it.

2. Injecting SIMPONI using SmartJect

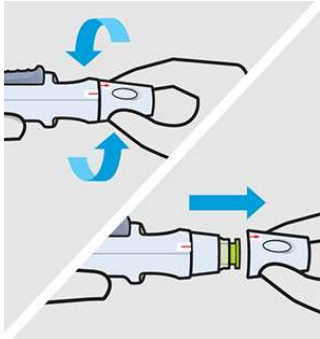

Remove cap

Twist the cap to break the security seal, then pull it straight off. Dispose of the cap right away.

It is important to **inject within 5 minutes** of removing the cap.

Do not put the cap back on, this may damage the hidden needle.

Do not inject if SmartJect is dropped **without** the cap on.

Do not pinch the skin while injecting. Pinching the skin can cause failure of the device and injury, including needlestick injury.



Position

Hold SmartJect comfortably with one hand **above the blue button** and position it straight onto your skin, as shown.

Make sure the green safety sleeve is stable and as flat as possible against your skin. If the device is not stable during the injection, you risk bending the needle.

Do not pinch your skin while positioning SmartJect onto your skin.

Do not pinch the skin to avoid injury, including needlestick injury.

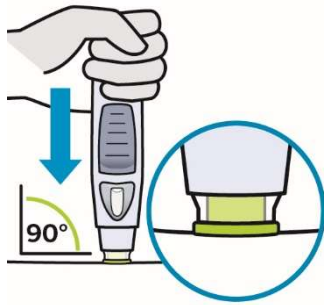

Push down

Push the open end of SmartJect against your skin at a 90-degree angle. Apply enough pressure to slide the green safety sleeve up and to keep it inside the clear cover. Only the wider part of the green safety sleeve stays outside of the clear cover.

Do not touch or press the blue button while pushing SmartJect against your skin.

⚠️ The green safety sleeve helps prevent accidental injections.

Pushing the blue button before the safety sleeve is pressed down can lead to device failure.

Inject without pinching the skin.

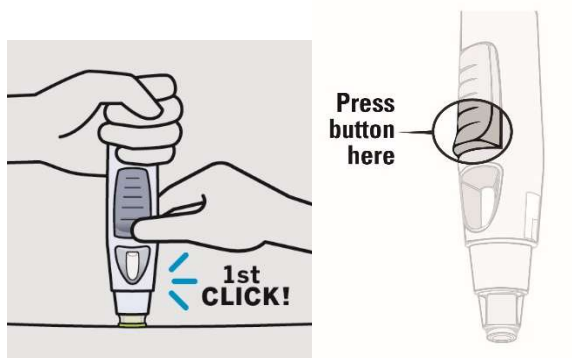

Press button and wait

Keep holding SmartJect against your skin. Use your **other hand** to press the **raised part of the blue button** to start your injection. **Do not** press the button until SmartJect is pressed against your skin and the safety sleeve slides into the clear cover.

You will hear a **loud 1st 'click'** as you press the button. This is normal, the medication is just beginning to be delivered. You may or may not feel a needle prick.



Listen for 2nd 'click'

Keep holding SmartJect against your skin until you hear the **2nd 'click'** (or for 15 seconds). It usually takes about 3-6 seconds, but may take up to 15 seconds for you to hear the second 'click' sound.

The 2nd 'click' means the injection is complete and you can lift SmartJect from your skin.

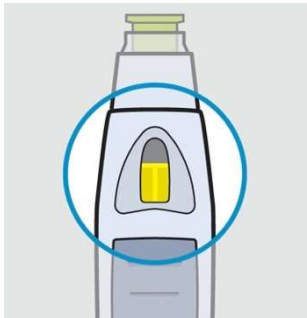

Check the viewing window

After lifting SmartJect from your skin, look for the yellow indicator in the viewing window to confirm SmartJect worked properly. The yellow indicator will fill about half of the viewing window.

If you do not see the yellow indicator, call 800-JANSSEN (800-526-7736).

Do not administer a second dose without speaking to your doctor.

3. Disposing of SIMPONI SmartJect

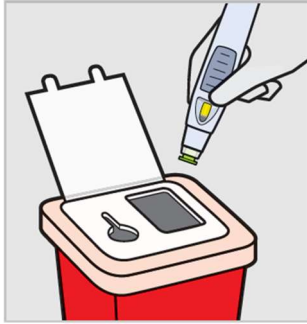

Dispose of your SmartJect

Put your used SmartJect in an FDA-cleared sharps disposal container right away after use.

Do not recycle your used sharps disposal container.

For more information, see “Helpful tips”.



Check injection site

There may be a small amount of blood or liquid at the injection site.

Hold pressure over your skin with a cotton ball or gauze pad until any bleeding stops.

Do not rub the injection site.

If needed, cover injection site with a bandage. Your injection is now complete!



Need help?

Call your doctor or pharmacist to talk about any questions you may have. For additional assistance or to share your feedback call 800-JANSSEN (800-526-7736).

Helpful tips

If you are having difficulty injecting:

- ✓ Make sure the cap is removed.
- ✓ Make sure SmartJect is pushed against your skin, so the green safety sleeve slides into the clear cover.
- ✓ Make sure you are pressing the **raised part of button**.
- ✓ If the button is hard to depress, do not press the button harder. Let go of the button, then lift SmartJect and start again. Ensure no pressure is on the button until the green safety sleeve is fully depressed against the skin, then press the button.
- ✓ Try a different injection site.

Additional Disposal Information

If you do not have an FDA-cleared sharps disposal container, you may use a household container that is:

- made of a heavy-duty plastic
- can be closed with a tight -fitting, puncture-resistant lid, without sharps being able to come out
- upright and stable during use
- leak-resistant
- properly labeled to warn of hazardous waste inside the container

When your sharps disposal container is almost full, you will need to follow your community guidelines for the right way to dispose of your sharps disposal container. There may be state or local laws about how you should throw away used needles and syringes.

For more information about safe sharps disposal, and for specific information about sharps disposal in the state that you live in, go to the FDA's website at: www.fda.gov/safesharpsdisposal

This Instructions for Use has been approved by the U.S. Food and Drug Administration.

Manufactured by:
Janssen Biotech, Inc.
Horsham, PA 19044, USA
US License No. 1864

Revised: November 2023

Instructions for Use
SIMPONI[®]
(SIM-po-nee)
(golimumab)
Prefilled Syringe



SINGLE-DOSE

Important

SIMPONI comes as a single-dose prefilled syringe containing one 50 mg or one 100 mg dose. Each SIMPONI prefilled syringe can only be used one time. Throw away (dispose of) the used prefilled syringe (See Step 3) after one dose, even if there is medicine left in it. Do not reuse your SIMPONI prefilled syringe.

If your healthcare provider decides that you or a caregiver may be able to give your injections of SIMPONI at home, you should receive training on the right way to prepare and inject SIMPONI using the prefilled syringe before attempting to inject. Do not try to inject yourself until you have been shown the right way to give the injections by your healthcare provider.

Read this Instructions for Use before using your SIMPONI prefilled syringe and each time you get a refill. There may be new information. This leaflet does not take the place of talking with your healthcare provider about your medical condition or your treatment.

The SIMPONI prefilled syringe is intended for injection under the skin, not into the muscle or vein. After injection, the needle will retract into the body of the device and lock into place.



Storage information

Store SIMPONI in the refrigerator at **36° to 46°F** (2° to 8°C).

If needed, store SIMPONI at room temperature, up to 77°F (25°C) for one period of time up to 30 days. Do not return it to the refrigerator. Throw away if not used within 30 days at room temperature.

Do not freeze SIMPONI prefilled syringe.

Do not shake SIMPONI prefilled syringe.

Keep SIMPONI prefilled syringe in the original carton to protect from light before use.

Keep SIMPONI prefilled syringe and all medicines out of the reach of children.

Prefilled syringe parts

Before use

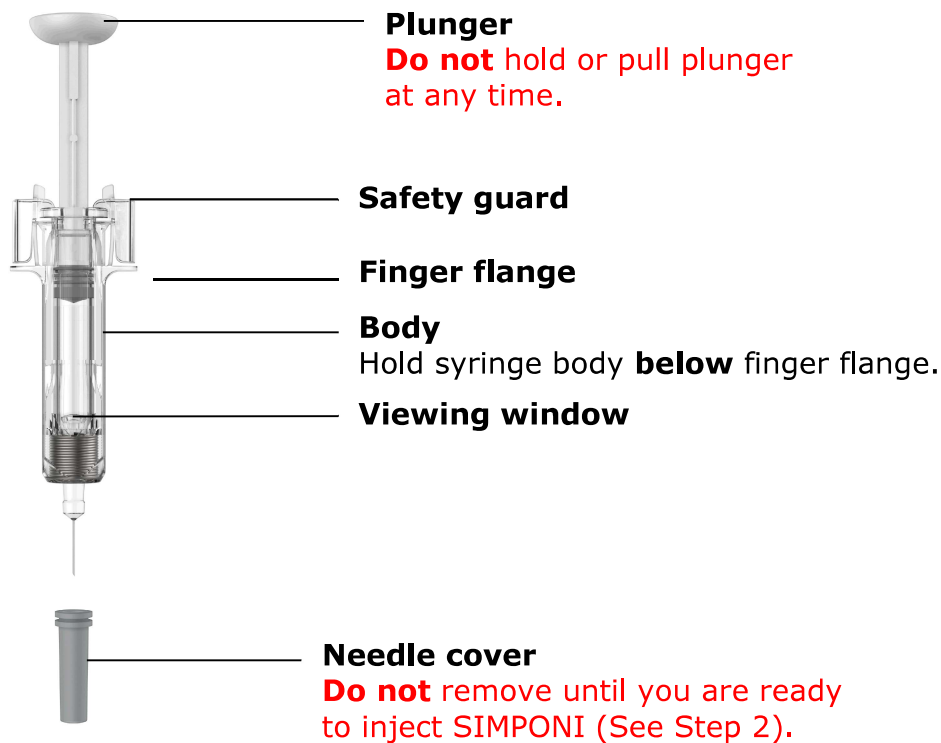

After use

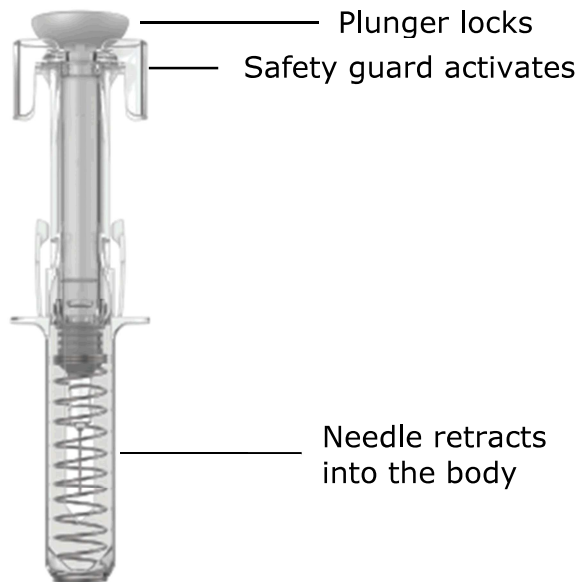

You will need these supplies:

- **1 SIMPONI prefilled syringe**
- **Not provided in the SIMPONI prefilled syringe carton:**
- **1 Alcohol swab**
- **1 Cotton ball or gauze pad**
- **1 Adhesive bandage**
- **1 Sharps container (See Step 3)**

1. Prepare for your injection

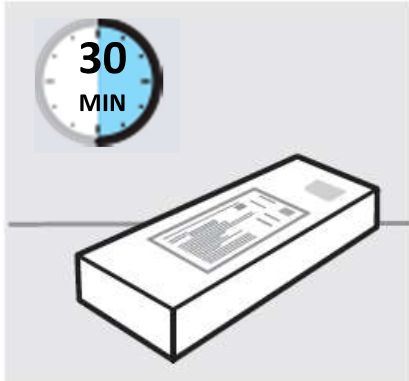

Inspect carton

Remove your SIMPONI prefilled syringe carton from the refrigerator.

Remove the prefilled syringe from the carton and let it sit on a flat surface at room temperature for **at least 30 minutes** before use.

Do not warm the prefilled syringe any other way.

Check the expiration date ('EXP') on the back panel of the carton and on the prefilled syringe (through the viewing window).

Do not use your prefilled syringe if the expiration date has passed.

Do not inject SIMPONI if the perforations on the carton are broken. Call your healthcare provider or pharmacist for a refill.

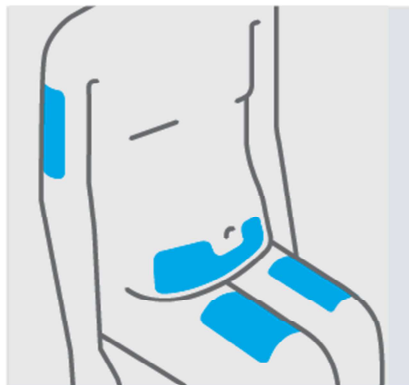

Choose injection site

Select from the following areas for your injection:

- **Front of thighs** (recommended)
- Lower stomach area (lower abdomen), except for a 2-inch area right around your navel (belly-button)
- Back of upper arms (only if someone else is giving you the injection)

Choose a different site within your preferred area for each injection.

Do not inject into skin that is tender, bruised, red, hard, thick or scaly.

Do not inject into areas with scars or stretch marks.

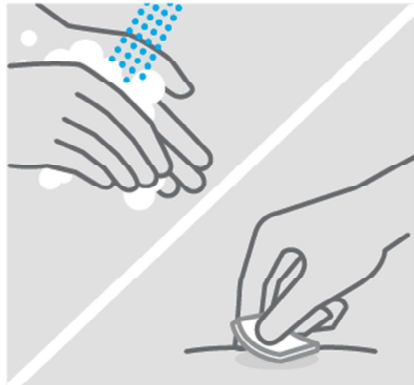

Clean injection site

Wash your hands well with soap and warm water.

Wipe your chosen injection site with an alcohol swab and allow it to dry.

Do not touch, fan, or blow on the injection site after you have cleaned it.

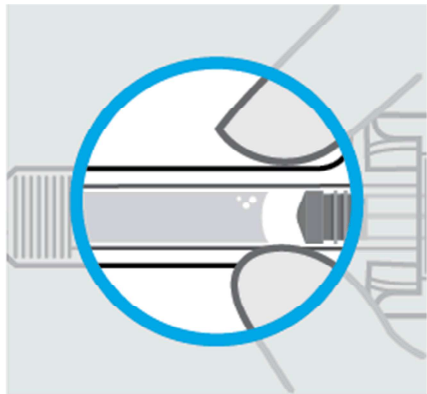

Inspect liquid

Check the SIMPONI prefilled syringe liquid in the viewing window. It should be clear to slightly yellow and may contain tiny white or clear particles. You may also see one or more air bubbles. This is normal.

Do not inject if the liquid is cloudy or discolored, or has large particles. Call your healthcare provider or pharmacist for a refill.

2. Inject SIMPONI using prefilled syringe

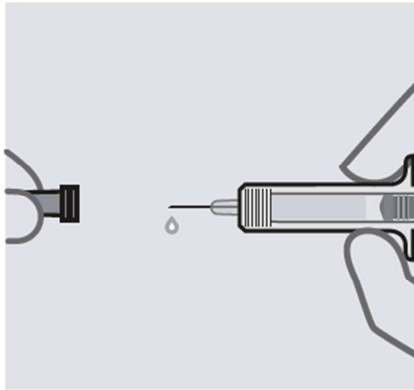

Remove needle cover

Hold your prefilled syringe by the body and pull needle cover straight off. It is normal to see a drop of liquid.

Inject SIMPONI within 5 minutes of removing the needle cover.

Do not put needle cover back on, as this may damage the needle or cause a needle stick injury.

Do not touch needle or let it touch any surface.

Do not use a SIMPONI prefilled syringe if it is dropped. Call your healthcare provider or pharmacist for a refill.

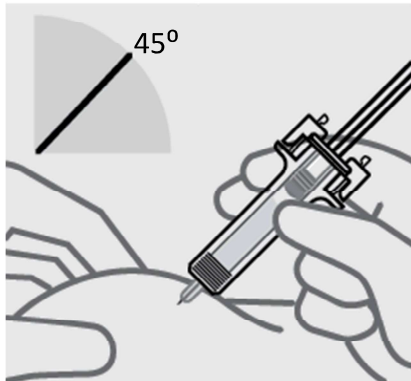

Position fingers and insert needle

Place your thumb, index and middle fingers **directly under the finger flange**, as shown.

Do not touch plunger or area above finger flange as this may cause the needle safety device to activate.

Use your other hand to pinch skin at the injection site. Position syringe at about a 45 degree angle to the skin.

It is important to pinch enough skin to **inject under the skin** and not into the

muscle.

Insert needle with a quick, dart-like motion.



Release pinch and reposition hand

Use your free hand to grasp the body of the prefilled syringe.

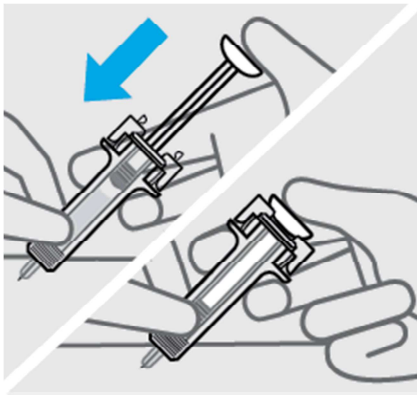

Press plunger

Place thumb from the opposite hand on the plunger and press the plunger **all the way down until it stops.**

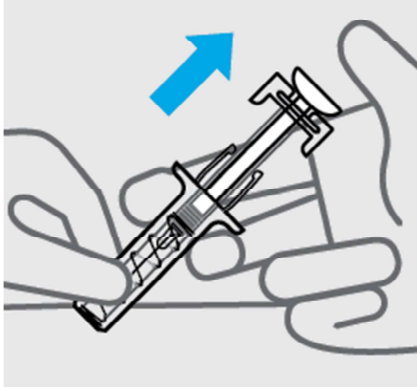

Release pressure from plunger

The safety guard will cover the needle and lock into place, removing the needle from your skin.

3. After your injection



Dispose of your prefilled syringe

Put your used SIMPONI prefilled syringe in an FDA-cleared sharps disposal container right away after use.

Do not throw away (dispose of) your SIMPONI prefilled syringe in your household trash.

Do not recycle your used sharps disposal container.

For more information, see “How should I dispose of the used prefilled syringe?”

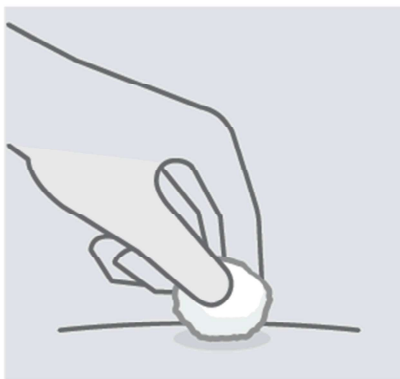

Check injection site

There may be a small amount of blood or liquid at the injection site. Hold pressure over your skin with a cotton ball or gauze pad until any bleeding stops.

Do not rub the injection site.

If needed, cover injection site with a bandage.



Need help?

Call your healthcare provider to talk about any questions you may have. For additional assistance or to share your feedback call 800-JANSSEN (800-526-7736).

How should I dispose of the used prefilled syringe?

If you do not have an FDA-cleared sharps disposal container, you may use a household container that is:

- made of a heavy-duty plastic
- can be closed with a tight-fitting, puncture-resistant lid, without sharps being able to come out
- upright and stable during use
- leak-resistant
- properly labeled to warn of hazardous waste inside the container

When your sharps disposal container is almost full, you will need to follow your community guidelines for the right way to dispose of your sharps disposal container. There may be state or local laws about how you should throw away used needles and syringes.

For more information about safe sharps disposal, and for specific information about sharps disposal in the state that you live in, go to the FDA's website at: www.fda.gov/safesharpsdisposal

This Instructions for Use has been approved by the U.S. Food and Drug Administration.

Manufactured by:
Janssen Biotech, Inc. Horsham, PA 19044
US License No. 1864

Revised: May 2018



cp-74833v7